

## NOTES ON THIS MANUAL

Keep these instructions with your computer at all times. The proper set up, use and care can help extend the life of your computer. In the event that you transfer ownership of this computer, please provide these instructions to the new owner.

This manual is divided into sections to help you locate the information you require. Along with the Table of Contents at the beginning of this manual, an Index has been provided to help you find topical information.

If you want to start up your PC immediately, please read the chapters **Operational Safety** (page 3) and **Setting up and Getting Started** (page 8).

We strongly recommend you read this entire manual to ensure the proper set-up and operation of your PC.

Many application programs incorporate extensive help functions. As a general rule, you can access help functions by pressing F1 on the keyboard. These help functions will be available to you while you are using the Microsoft Windows® operating system or the respective application program.

We **strongly recommend** that you read the Online Manual for your PC, which can be found in the **Start Menu**.



### **Information about your PC**

This interactive manual is designed to provide additional information about your PC as well as useful links accessible via the World Wide Web.

Windows<sup>xp</sup> invites you to a **tour** (notes on the task bar) to familiarize yourself with the operating system. We listed further useful sources of information starting on page 67.

## AUDIENCE

These instructions are intended for both the novice and advanced user. Regardless of the possible professional utilisation, this PC is designed for day-to-day household use. The functions and applications for use with this PC have been designed with the entire family in mind.

## PURCHASE DETAILS

Enter your purchase details below for quick reference.

Serial Numbers .....  
(i.e. Microsoft®) .....  
Place and date of Purchase .....

You will find the PC serial number on the Service Hotline card. The serial number also appears on the rear of the PC.

## QUALITY

Medion has selected the components in this computer for their high level of functionality, ease of use, safety and reliability.

Through balanced hardware and software design we are able to provide you with an innovative personal computer useful for applications relating to both work and leisure.

We are pleased to welcome you as our newest customer. **Thank you for choosing our products.**

© 2005 Medion®. All rights reserved. Microsoft®, MS-DOS®, and Windows are registered trademarks of Microsoft Corporation in the U.S. and other countries. Pentium® is a registered trademark of Intel Corporation. The names of actual companies and products mentioned herein may be the trademarks of their respective owners.

**Information in this document is subject to change without notice.**

# Table of contents

- Safety..... 1**
  - Operational safety..... 3
  - Data security ..... 4
- Setting up & Getting started..... 5**
  - Included with your PC..... 7
  - Setting up..... 8
    - Set-up location..... 8
    - Ambient temperature ..... 8
    - Ergonomics..... 9
  - Connecting ..... 12
    - Cabling ..... 12
    - Front connectors ..... 13
    - Connecting the monitor ..... 14
    - Installing wireless keyboard & mouse ..... 15
      - Inserting batteries in mouse ..... 15
      - Inserting batteries in keyboard..... 16
      - Setting the frequency channel or ID..... 17
      - Connecting the receiver ..... 18
    - Connecting a USB keyboard/mouse..... 19
    - Connecting a PS/2 keyboard/mouse ..... 19
    - Connecting parallel devices ..... 19
    - Modem/ISDN connection ..... 20
      - Modem ..... 20
      - ISDN ..... 20
    - Connecting serial devices..... 21
    - LAN connection ..... 21
    - Connecting speakers/audio output ..... 22
      - PCs with surround sound ..... 22
    - Connecting a sound source/audio input..... 23
    - Connecting a recording source / video inlet ..... 23
    - Connecting the PC to a television (TV-out) ..... 24

Connecting a microphone .....	24
Antenna connection for TV receiver .....	25
Operation with one antenna .....	25
Operation with two antennas .....	25
DVB-S TV reception .....	25
USB/IEEE 1394 .....	26
Connecting IEEE 1394 (Fire Wire) devices.....	26
Connecting USB devices .....	26
Connecting the power supply.....	27
Getting started .....	29
Step 1: Power on.....	29
Switch .....	29
On/off switch .....	29
Step 2: Starting initial setup .....	30
Step 3: Finalizing .....	31
Short description of the Windows® desktop .....	31
<b>Operation .....</b>	<b>33</b>
The multifunction display .....	35
Multimedia at the press of a button .....	36
Switch Power Cinema on .....	36
Switch Power Cinema off .....	36
The mouse.....	37
Power-saving function .....	37
The keyboard .....	38
The Alt and Ctrl keys.....	38
Multimedia functions .....	39
The hard drive.....	41
Important directories .....	42
Connecting an external hard drive.....	43
The optical drive .....	44
Loading a disc:.....	44
Playing back and retrieving data from discs .....	45

How to remove a disc: .....	45
The optical drive as boot drive.....	45
Regional playback information for DVD .....	46
Subjects concerning the CD/DVD-Rewriter .....	47
LightScribe .....	47
The card reader .....	48
The graphics card .....	49
Performance characteristics .....	49
Current image playback frequencies .....	49
Connecting the PC to a television .....	50
How to connect the PC to a television: .....	51
The sound card.....	52
USB port .....	53
IEEE 1394 (Fire Wire).....	54
Application options for IEEE1394 .....	54
Technical specifications .....	54
The TV tuner card .....	55
Watch TV .....	55
The Dual Tuner functions.....	56
Switch position 1 (operation with one antenna) .....	56
Switch position 2 (operation with two antennas) .....	56
The remote control.....	58
Inserting batteries .....	58
Button layout.....	59
Changing the transmission/reception channels.....	62
The network.....	63
What is a network? .....	63
Wireless LAN.....	64
Safety notes.....	64
Conditions.....	64
Troubleshooting within the network.....	65
Modem / ISDN.....	66

Serial COM port .....	66
Software.....	67
Getting to know Windows <sup>xp</sup> .....	67
Windows <sup>xp</sup> home edition – first steps .....	67
Windows <sup>xp</sup> help and support .....	67
Microsoft interactive training .....	68
Writing CDs/DVDs .....	69
Starting Nero - Express.....	69
Installation of software.....	70
This is how to install your software: .....	71
Software uninstallation.....	72
Windows activation .....	73
Product activation on your PC .....	73
BIOS setup .....	74
Execution of the BIOS setup .....	74
<b>Customer service &amp; self help .....</b>	<b>75</b>
Data and system security .....	77
Data security .....	77
Maintenance programs .....	77
Password reset file.....	77
System recovery.....	78
Correction .....	78
Windows <sup>®</sup> Update.....	79
Windows Update information for data security .....	80
Restoring the factory settings.....	81
Limits of the recovery .....	81
Carrying out a restore.....	82
FAQ – Frequently Asked Questions .....	83
Customer service .....	85
Troubleshooting .....	85
Localise the cause .....	85
Errors and possible causes .....	86

- Additional support ..... 87
- Driver support..... 87
- Transporting the PC ..... 88
- Cleaning and care..... 88
- Recycling and disposal..... 89
- Battery treatment..... 89
- Upgrades and repairs ..... 91
- Notes for service engineers..... 91

**Appendix..... 93**

- PowerCinema Linux license agreement..... 95
- License disclaimer..... 95
- Download source code ..... 95
- Standards..... 96
- Electromagnetic compatibility ..... 96
- Electrical safety ..... 96
- Ergonomics..... 97
- Noise emission ..... 97
- Information about the regulatory compliance of the  
    modem ..... 98
- Information about the regulatory compliance of  
    wireless keyboard / mouse..... 98
- FCC compliance statement..... 99
- Warranty ..... 100
- Liability limitations..... 101
- Making copies of this manual..... 101
- Index ..... 102



### Device

At the end of its life, the appliance must not be disposed of in household rubbish. Enquire about the options for environmentally-friendly disposal



### Batteries

Do not dispose of used batteries in the household rubbish! They must be deposited at a collection point for used batteries.



# Chapter 1

---

## Safety

<b>Subject</b>	<b>Page</b>
Operational safety .....	3
Data security .....	4





# Operational safety

Please read this chapter carefully and observe all listed notes. This ensures a reliable operation and long life expectancy of your PC.

 **Do not allow children to play unattended with electrical equipment.** Children are incapable of judging potential risks properly.

 Do not open the PC casing or use the PC with the casing removed. When the casing is open there is a danger to life from electric shock.

 Optical drives are Laser Class 1 devices. These lasers must remain in their sealed PC casing. Do not remove the drive covers, as exposure to the lasers may prove harmful.

 **Do not insert objects through the slots and openings of the PC.** This may lead to electric shock or an electrical short-circuit or fire that will damage your PC.

 **Do not cover the slots and openings in the PC casing.** These openings are for ventilation purposes. Covering these vents may lead to overheating.

**Switch off your PC immediately** or do not switch it on at all and contact customer service ...

- ... if the power cord or the connectors attached to it are burnt or damaged. Replace the defective power cord with an original power cord. Under no circumstances may a defective power cord be repaired.
- ... if the **housing** of the PC is **damaged** or **fluids have leaked into it**. Have the PC checked by customer service first, because the PC may not be safely operated otherwise and there may be a life-threatening risk of electrocution!

## DATA SECURITY



---

**Attention!** Every time you update your data make back-up copies on an external storage medium. The supplier does not assume liability for data loss or damage to data storage units, and no claims can be accepted for damages resulting from the loss of data or consequential losses.

---

---

# Chapter 2

## Setting up & Getting started

<b>Subject</b>	<b>Page</b>
Included with your PC .....	7
Setting up .....	8
Connecting .....	12
Getting started .....	29



# Included with your PC

Please check that the contents listed below are supplied with your package and notify us **within 14 days of purchase** if this is not the case. You **MUST** provide your PC's serial number when contacting a customer service representative.

Your PC bundle should include the following components:

- PC and power cord
- Windows-compatible keyboard & mouse
- Headset
- Remote control
- Microsoft Windows® Getting Started manual + recovery CD
- Application-/ Support Disc
- Documentation

# Setting up

Remember that choosing the proper location for your PC is just as important as connecting it correctly. Place your PC in a stable, vibration-free area. Detailed below are additional guidelines on setting up your PC.

## SET-UP LOCATION

- Keep your PC and all units connected to it away from **mois-ture, dust, heat** and **direct sunlight**. Failure to observe these instructions can lead to malfunctions or damage to the PC.
- To prevent damage to your PC from a fall, place and operate the PC and all connected units on a **stable, balanced** and **vibration-free surface**.
- Your PC is not suitable for use at video workstation devices in the sense of §2 of the video workstation regulation.

## AMBIENT TEMPERATURE

- The PC can be operated at an ambient temperature of between **10°** and **35°C** (+41° and +95°F) and at a relative humidity of between **30%** and **70%** (without condensation).
- When powered off, the PC can be stored at temperatures between **-20°** and **50°C** (-40° and +158°F).
- Unplug the cable during **thunderstorms** and make **espe-cially** sure to remove the antenna cables, if present. We recommend the use of a **surge protector** for additional safety, in order to protect your PC from being damaged by **power peaks** or **lightning strikes** through the power network.
- Delay operating a PC after transport until the device has adjusted to the ambient temperature. In situations of large **temperature or humidity differences** condensation may build up moisture inside the PC, which might cause an **elec-trical short circuit**.



## ERGONOMICS

 **Note:** Ensure that the monitor is set up in such a way that reflections, glare and light/darkness contrast are avoided.

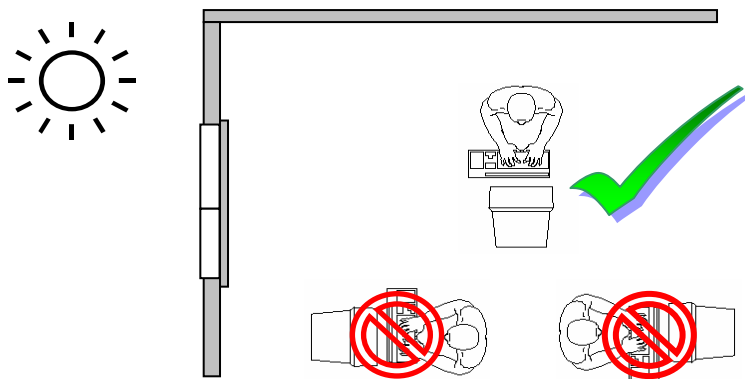

You should not position the monitor in close proximity to a window, because this is the brightest area of the room because of daylight. This brightness impedes the adjustment of the eyes to the darker monitor.

Always position the monitor in a line of sight that runs parallel to the window front (see picture).

You should also apply a parallel line of sight with respect to artificial lighting. This means that in a room lit by artificial light essentially the same criteria and objectives apply. Should it not be possible to arrange the monitor as outlined above, the following measures might be helpful:

- Turn, lower or incline the monitor.
- Place horizontal or vertical shades at the windows.
- Working in Comfort

 **Note:** Take **regular breaks** from the work at your screen to prevent tenseness and exhaustion.

Sitting in one position for long periods can be uncomfortable. To minimize the potential for physical discomfort or injury, it's important that you maintain proper posture.

**Overall:**

Change your position frequently and take regular breaks to avoid fatigue.

**Back:**

While sitting at your work surface, make sure your back is supported by the chair's backrest in erect position or angled slightly backwards.

**Legs:**

Your thighs should be horizontal or angled slightly downward. Your lower legs should be near a right angle to your thighs. Your feet should rest flat on the floor. If necessary, use a footrest, but double check that you have your seat height adjusted correctly before getting a footrest.

**Arms:**

Your arms should be relaxed and loose, elbows close to your sides, with forearms and hands approximately parallel to the floor.

**Wrists:**

Your wrists should be as straight as possible while using the keyboard, mouse or trackball. They should not be bent sideways, or more than 10 degrees up or down.

**Head:**

Your head should be upright or tilted slightly forward. Avoid working with your head or trunk twisted.



- Hand rest: 2" – 4"
- Top line of screen at eye level or slightly below
- Viewing distance: 20" – 27.5"
- Legroom (vertical): minimum 25.5"
- Legroom (horizontal): minimum 23.6"

# Connecting

**For a better guidance, open up the left inner page of the cover with the diagrams to find the location of the described connections.**



---

**Note:** The devices listed are **not necessarily included** with your PC.

All the **connections** listed are **optional** and will not inevitably be available on your PC.

---

## CABLING

Please follow the instructions below in order to correctly connect your PC:

- Arrange cables in such a way that no one can tread on or trip over them.
- **Do not place objects on the cables.**
- To avoid damage to your PC, connect your peripherals (e.g., keyboard, mouse and monitor) whilst your PC is powered **off**. Some devices can be connected whilst your PC is in use. These devices usually have a USB or IEEE 1394 connector. **Please follow the appropriate instructions for each device.**
- Keep the PC at least one meter (approximately three feet) away from **high frequency** and **magnetic interference sources** (e.g., televisions, loudspeaker cabinets, mobile telephones, etc.) in order to avoid malfunctions and/or loss of data.
- Please note that only **shielded** cables shorter than 3 metres (9.84 ft) should be used for the LPT, COM, USB, IEEE 1394, audio, video and network interfaces with this PC.
- To avoid EMC issues, make sure that all devices are connected to each cable or that cables not in use are removed from the computer.

- The connection of devices is limited to equipment that complies with EN60950 "Safety of information technology equipment" or EN60065 "Audio, video and similar electronic apparatus. Safety requirements".



**Note:** You only need to connect those components to your computer you require. If you do not have the described device (e. g. printer) you may skip the respective item and carry it out later, if necessary.

## FRONT CONNECTORS

Here is how you can access the card reader and some further connectors on the front of your PC casing.

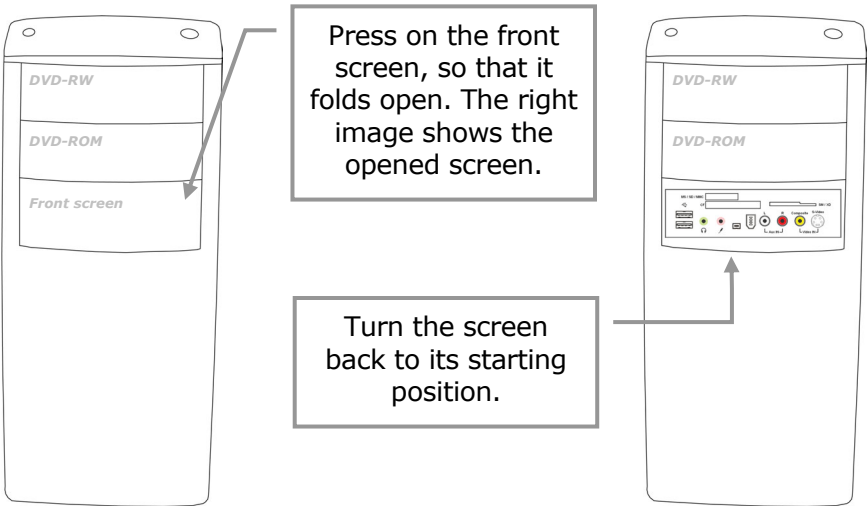

## CONNECTING THE MONITOR

Diagram reference: **W**, **W2**

If your graphics card has two VGA sockets, you can use either port to connect to the monitor. Your PC may optionally be equipped with a digital connector (DVI, **W2**). With the help of an adapter you can also use this connector for your VGA monitor.



---

Because of its asymmetric form the plug only fits into the socket in one position.

---

1. Connect the data cable of the monitor to the socket on the graphics card (reference **W** or **W2**). If necessary, remove the white guard-ring on the monitor plug and ensure that the plug and socket mate together precisely.
2. Hand-tighten the screws on the monitor cable.



---

**CAUTION!** Your PC monitor is preconfigured for a screen resolution of **1024 x 768** pixels and an optimal refresh rate of 75 hz. If your monitor does not support these settings it may become damaged or malfunction during use.

---

You can change the screen resolution and configuration of your monitor as follows (See also your monitor's User Manual):

1. Once you have powered on the PC, press the F8 key to select **Safe Mode**.



---

If you don't hit the F8 key on time, you won't see the start menu which gives you the option to run in **Safe Mode**. Reboot your PC and retry if you have missed this.

---

2. Select **Display Properties** to designate the screen resolution for your monitor.
3. You can then adjust the "**Display Features**" to your monitor.

## INSTALLING WIRELESS KEYBOARD & MOUSE

These devices are optional. The wireless keyboard and mouse operate with digital radio technology to ensure no hinder communication between the keyboard, the mouse and your computer without connecting cable. The transmission and receiving of keyboard and mouse are free from angle restriction. Before working with your new keyboard and mouse, take a few one-time preparations.



**Beware:** Please read and follow the security advices concerning the use of batteries on page 89.

### INSERTING BATTERIES IN MOUSE

The mouse requires 2 rechargeable NiMH batteries (Type: AAA).



**Note:** Please use only rechargeable batteries. The use of customary batteries can lead to malfunctions or damage to the mouse.

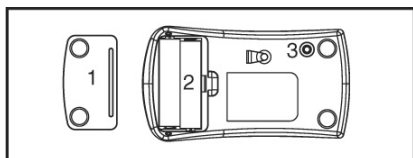

- 1 = cover
  - 2 = battery compartment
  - 3 = channel setting button
- (Diagram the same)

Remove the battery compartment cover (1) on the bottom of the mouse.

1. Insert the two rechargeable NiMH batteries (AAA) in the battery compartment.
2. Replace the battery compartment cover (1) on the bottom of mouse
3. The mouse is charged by your PC using the supplied USB-cable. Connect the cable end with the small connector on the front side of the mouse and the other cable end with your PC, while the PC is switched on. Charging is completed after about 8 hours. You can continue using the mouse while it is charging.

## INSERTING BATTERIES IN KEYBOARD

The keyboard requires two alkaline batteries (AA).

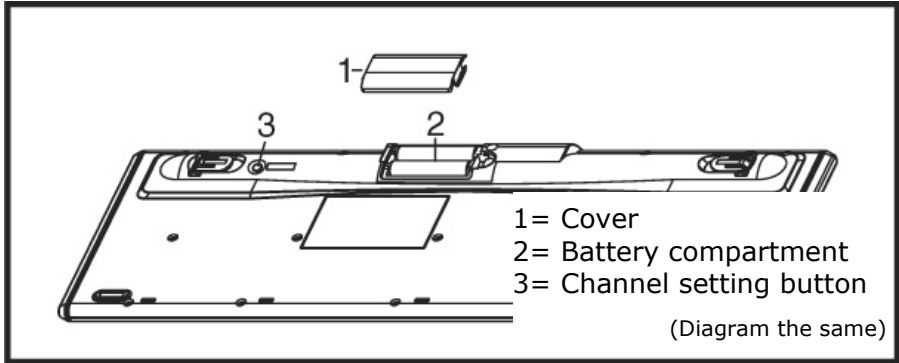

1. Remove the battery compartment cover (1) on the bottom of the keyboard by pushing it in the direction of the arrow.
2. Insert two AA batteries. The illustration on the cover shows how to insert the batteries properly.
3. Recover the battery compartment.



**Note:** Please do not push the channel setting button (3) to the side of the battery compartment cover. It may cause the channel or ID to change.



## SETTING THE FREQUENCY CHANNEL OR ID

---

 **Important:** Do **not** carry out the following installation steps **until** you have put the PC into operation as described on the following pages.

---

For a good wireless radio connection, you must ensure the frequency channel and/or ID of the keyboard and mouse is the same as that of the receiver.

There are 255 IDs each for keyboard and mouse. Changing the frequency channel / ID may prevent interference between devices.

### Setting the frequency channel of the keyboard and mouse

1. Push the 'connect' button located on top of the receiver. The indicator will start blinking.
2. Push the button on the bottom of the keyboard and/or the mouse. The channel will be changed after the button is released.

---

 **Note:** Please do not hold the button for more than 3 seconds. This will change the ID, instead of the channel.

---

### Setting the ID on the keyboard and mouse

1. Push the 'connect' button on top of the receiver. The indicator light on the receiver will start blinking.
2. Hold down the button on the bottom of the keyboard and/or the mouse for 3 seconds. The ID will change after the button has been released.

## CONNECTING THE RECEIVER

Diagram reference: **E**

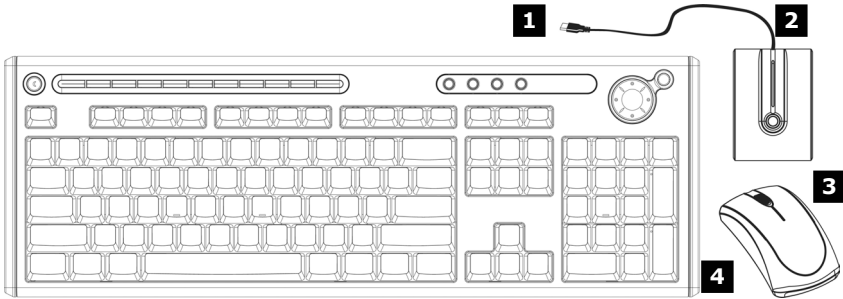

- 1 = USB receiver plug (black)
- 2 = Receiver
- 3 = Mouse
- 4 = Keyboard

1. Attach the USB receiver for the mouse and the keyboard to any free USB connection. It is recommended to use a connection at the back of the PC because of the visual appearance.
2. The distance between the reception station and the transmitter (keyboard and mouse) should not exceed 20 cm, in order to receive optimum wireless conditions.



**Note:** Change the batteries if it is no longer possible to make entries smoothly.

The operation of the mouse and the keyboard is described on page 37.

## CONNECTING A USB KEYBOARD/MOUSE

Diagram reference: **E**

1. Connect the USB keyboard or mouse to a free USB port.

## CONNECTING A PS/2 KEYBOARD/MOUSE

Diagram reference: **R / O**

If you intend to connect a USB keyboard or mouse, you can skip this step.

1. Connect the PS/2 keyboard to the blue PS/2 port and the mouse to the green PS/2 port.

## CONNECTING PARALLEL DEVICES

Diagram reference: **P**



---

Take care that the connector and the socket fit exactly to avoid damaging the contacts. Because of its asymmetric form the plug only fits into the socket in one position.

---

Use a doubly screened, parallel connection cable (25-pin) to connect a printer:

1. Connect the printer cable from your printer to the red printer socket **P** on the rear of your PC.
2. Hand-tighten the screws of the printer cable.

If you wish to use a **scanner**, which also connects to the PC via the parallel interface, follow the instructions above. With the PC parallel port in use, the printer can be connected directly to the scanner. You will have use of both devices if they are connected in this manner.

## MODEM/ISDN CONNECTION

Diagram reference: **Z**

Your PC may be fitted with an analogue modem or an ISDN card to prepare your PC for Internet access and fax operation, according to the equipment.

### MODEM

The modem cable has an **RJ11** plug, which is plugged into the modem of your PC, and a **TAE** plug, which fits an N-coded, analogue telephone socket.



---

**Attention!** Please observe that the modem may only be connected to an **analogue** telephone line. The connection of a digital system (ISDN etc.) to an analogue telephone line can possibly cause damage to the modem or the connected devices and the telecommunication network.

---

### ISDN

The ISDN cable has **RJ45** plugs at either end. It makes no difference which end is plugged into which socket.

1. Connect the matching plug of the enclosed communication cable to jack **Z** of your computer. Usually the jack is marked with "Line".
2. Then connect the other plug the telephone or ISDN outlet.



---

**Attention!** Operate the **ISDN** unit only with **digital** telephone systems. This prevents an inadmissible operation possibly causing damage to the unit or the connected devices.

---

## CONNECTING SERIAL DEVICES

Diagram reference: **S**

You can connect an external modem or another serial device using this port.



---

Take care that the connector and the socket fit exactly to avoid damaging the contacts. Because of its asymmetric form the plug only fits into the socket in one position.

---

1. In order to connect an external modem, card reader or other serial device, connect the serial cable with the turquoise-coloured connection socket (**S**) on the rear of your PC.
2. Hand-tighten the screws of the serial cable.

## LAN CONNECTION

Diagram reference: **Q**

Your PC is equipped with a network connection, in order to prepare it for network operation.

The network cable usually has two **RJ45** plugs so that it is unimportant which plug is connected to which jack.

1. Connect the one plug of the cable to the PC jack.
2. Connect the other plug to the other PC or hub/switch.

For further information refer to chapter "**The Network**" starting at page 56.

## CONNECTING SPEAKERS/AUDIO OUTPUT

Diagram reference: **H**

Here you can connect your **headphones, active speakers** or **audio connection cables** for recording. Please refer to the user's guide of your stereo installation for information about which connector you should use (usually **Line In** or **Aux**).

1. Connect your **headphones** or **active speakers** by plugging the cable with the **3.5 mm stereo** jack plug into the green socket (reference **H**).

## PCS WITH SURROUND SOUND

Diagram reference: **H, H2, H3, H4, U, U2**



---

**Note:** You will find information about placing speakers by starting the sound software in the task bar

---

Connect your surround equipment as follows:

1. Connect the **Front** speaker to the green socket (reference **H**).
2. Connect your rear speaker to the **Surround 1** connector (**H2**).
3. Your centre speaker or subwoofer can be connected to the socket **Centre/Subwoofer (H3)**.
4. Connect to the optional **Surround 2** socket (**H4**) two more speakers for the back surround.

A **digital audio output (SPDIF)** can be connected with an optical and/or coaxial cable.

1. Push the cinch cable into the socket at Position **U**. Push the optical cable into the output at Position **U2**.
2. Connect the other end of the cable to an audio device that has a corresponding digital input.

## CONNECTING A SOUND SOURCE / AUDIO INPUT

Diagram reference: **J, J2, T, T2**

This port is used to accommodate a connecting cable for external audio sources (i.e. stereo system, keyboard/synthesizer).

1. Connect the cable with the **3.5 mm stereo** jack plug to the light-blue coloured socket (reference **J**). You can also connect a stereo Cinch cable (position **J2**).

If you want to record a digital audio source use the (optional) audio input **T** or **T2**. A **SPDIF**-Cinch cable will also be necessary for the **T** while **T2** is an optical output.

## CONNECTING A RECORDING SOURCE / VIDEO INLET

Diagram reference: **K, L**

Depending on the configuration you can connect an external video source to your PC using an S-Video or composite (cinch) cable. These connections enable you to record and, if necessary, edit video data.

1. Connect the plug of the cord to the jack (position **K** for cinch and **L** for S-Video).



---

**Attention:** These two front connectors cannot be used simultaneously.

---

## CONNECTING THE PC TO A TELEVISION (TV-OUT)

Diagram reference: **V, V2, V3, V4**

If your computer's VGA card is equipped with a TV-Out socket you can establish a connection to a TV. Depending on the configuration you can use a composite cable (cinch, **V**), an S-Video cable (**V2**) a SCART cable (**V3**) or a component cable (**V4**).



---

**Note:** These sockets are only for output purpose.

---

1. Connect your PC and your television with the cord required for your TV.

## CONNECTING A MICROPHONE

Diagram reference: **I**

1. You can use the pink socket **I** to connect a microphone with a **3.5 mm** mono jack plug.
2. Position the microphone in such a way that it does not point directly at the speakers. If you hear feedback, characterised by loud whistling noises, reposition the microphone until the sound stops.



## ANTENNA CONNECTION FOR TV RECEIVER

Diagram reference: **Y, Y2, Y3, Y4**



---

**Caution!** The **heat** that the installed tuner produces can be **transmitted to the antenna connections**, because of the **high performance** of your TV card. Allow the **TV card to cool down** under all circumstances, before connecting or removing the antenna cable for this reason, to **avoid potential increases in temperature**.

---

### OPERATION WITH ONE ANTENNA

This setting is the **status at delivery**. Connect **one** antenna cable to the **Y2** main connection exclusively, to receive DVB-T **or** analog (e.g. cable) television. You will be able to receive two channels at the same time with one cable. Use this setting if you **only** have **one** antenna.

### OPERATION WITH TWO ANTENNAS

The TV card must be set at Position **2**, in order to be able to use this function. This change will only be necessary if you wish to use digital terrestrial (DVB-T) and analog (DVB-T) **at the same time**. Both antennas (**Y** and **Y2**) must be connected, to enable use of both at the same time.

### DVB-S TV RECEPTION

You will be able to view television with your digital satellite equipment through the two **DVB-S** connections (**Y3** and **Y4**). Both connections are designed as inputs. It will **not** be possible to loop the SAT signal through.



---

**Information:** Read the information from page 56 under all circumstances, in order to receive **further information about** the TV card and **the configuration of the antenna connections**.

---

## USB/IEEE 1394



---

**Warning:** Connect your USB-/IEEE 1394 devices **after initial set-up** of your new PC. This will prevent unnecessary confusion during installation. These devices can generally be connected during operation. Read the manual for your peripheral device first.

---

The voltage outputs of your PC for IEEE 1394 as well as for USB are protected by a fuse (limited power source according to EN60950). This ensures that a malfunction of the PC will not damage the peripheral devices connected to the respective jacks.

### CONNECTING IEEE 1394 (FIRE WIRE) DEVICES

Diagram reference: **F, F2**



---

**Note:** Peripheral devices can have different connecting cables (6-pole = **F**, 4-pole = **F2**). Please check what kind of cable you need for your peripheral device.



**Important:** The connectors of the front side are not configured for parallel use.

---

### CONNECTING USB DEVICES

Diagram reference: **E**

You have a choice of several connection sockets.

It does not matter which you use.

1. If you wish to use a **printer, scanner** or other device with a USB port, connect the cable to the USB socket on your PC.



---

**Note:** Connect your devices always to the same port otherwise your operating system will give a new ID and asks for driver installation.

---

## CONNECTING THE POWER SUPPLY

Diagram reference: **X, X2**

Finally, connect the power supply to your PC and monitor, by plugging the power cord into the outlet.

Observe the following **safety precautions**:



---

**Please note:** Even with the power switch switched off some parts of the device receive current. **You must unplug the power plug** from the socket, if you want to interrupt the power supply to your PC or cut off your device from current entirely.

---

- The power socket must be in the vicinity of the PC and within reach of the power cables. **DO NOT stretch the power cables tightly to reach a power socket.**
- Only operate the PC on grounded plugs of the domestic power net.
- Use **only** the supplied power cord.
- To provide additional protection against electric shock, power surges, lightning strikes, or other electrical damage to your PC, we recommend the use of a **surge protector**.
- If you are using an **extension cord**, ensure that the cord meets your local safety requirements. If in doubt, ask an electrician.
- The power supply unit has an On/Off switch (**X2**) that can be used to power off the PC. When the switch is **Off** (0) no power is being consumed.

### **DO NOT Start Your PC Yet!**

First, read the following section to find out what you need to know in order to get started.



# Getting started

The software on this PC comes **fully pre-installed**.

You do not have to load any of the CD's/DVD's supplied.

With many programs (e.g., telephone-CD's or encyclopaedias), however, it is necessary to insert the corresponding CD/DVD in order to call up the data which is stored on it. The software will ask you to do this as necessary.

Once you have made all the connections and secured the necessary connectors you can turn on the monitor, the other peripherals and finally the PC itself.

## STEP 1: POWER ON

1. Power on the monitor and your peripherals.

### SWITCH

Diagram reference: **X2**

2. Power on your PC by pressing the **Switch** to position [**1**]. (You will interrupt the current entry by pressing the switch to position **0**.)



### ON/OFF SWITCH

Diagram reference: **N**

3. Press **On/off switch** briefly to start loading the operating system.

You can program the function of the main switch in the power management of Windows® (please refer to on-line help). The PC will always be switched off, if the main switch is pressed for more than 4 seconds.



---

**Warning!** If the operating system is not shut down properly (through  ⇒ Shut Down), then there is a risk of data loss.

---

## STEP 2: STARTING INITIAL SETUP

The PC starts and now goes through a number of phases:



---

**Note:** Ensure that there is no bootable CD (e.g. the Recovery-CD) in the CD-ROM drive. Such disks will prevent the operating system from loading directly off the hard drive.

---

The **operating system** is loaded from the hard disk. During the initial set-up, the loading process takes slightly longer than normal to register the operating system and the individual components completely. Your operating system is finished loading when a welcome screen is shown on your display.

Follow the instructions on the screen. Dialogue boxes will explain any steps that need to be taken. The greeting procedure will guide you through the following screens and dialogues.

Should you have any questions just click on .

### License agreement

Please read through the license agreement carefully. It contains important legal information on the use of your software. In order to see the full text, use the mouse and the scroll bar to move downwards until you have reached the end of the document. You accept the agreement by clicking on the **I accept the agreement** option field. Only by doing so will you be entitled to use the product under lawful terms and conditions.

### Computer name

Please note, that when assigning a name to a computer, the **computer name** and the **user name** may not be identical.

## STEP 3: FINALIZING

After the login procedure the Windows® desktop appears on your screen.

This can be adjusted so that the screen of your computer looks different. The basic operation, however, is ensured.

### SHORT DESCRIPTION OF THE WINDOWS® DESKTOP

(The respective illustration is shown on the next page.)

#### ❶ The Start button

Click once on this button with your left mouse key to call the illustrated start menu.

#### ❷ Program bar

The most commonly used programs are listed here. The operating system recognizes them automatically. If you press the right mouse key on an entry you can determine which entry is kept and which is deleted from the list. The program associated with the entry will **not** be deleted.

#### ❸ All programs

Here you find the entries to every program installed on your PC. Here, too, you can edit entries with the right mouse key.

#### ❹ Information about your PC

Click on this button once with the left mouse key to receive important information about your PC as well as valuable hints and additional assistance.

#### ❺ Switching off

Click on this button with the left mouse key to switch off the PC.

#### ❻ Task bar

Here you receive information and status reports about the operating system and the running programs.

## 7 “Icons” on the “Desktop”

**Icons** are program links used to start the respective programs. A **double click** (press the left mouse key quickly twice) on the symbol starts the application.

The **Desktop** includes almost the complete screen and is the filing area for those entries or other links you would like to access quickly.

## 8 Logged in user

This shows the logged in user. The image is changed by clicking on it.

## 9 Control Panel

This is the central control of your computer. Here you are able to configure your computer at will. However, you should read about the implications of possible changes in “Help and Support”.

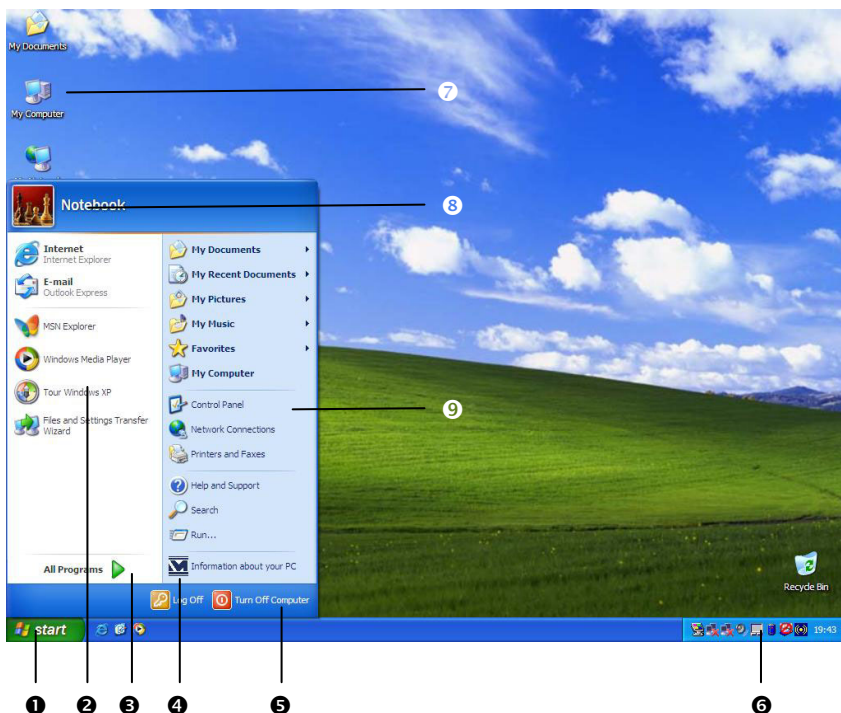



# Chapter 3

---

## Operation

<b>Subject</b>	<b>Page</b>
The multifunction display .....	35
Multimedia at the press of a button .....	36
The mouse .....	37
The keyboard .....	38
The hard drive .....	41
The optical drive .....	44
The card reader .....	48
The graphics card .....	49
The sound card .....	52
The USB port .....	53
IEEE 1394 (FireWire) .....	54
The TV tuner card.....	55
The remote control .....	58
Network .....	63
Modem / ISDN .....	66
Software .....	67



# The multifunction display

Your PC is supplied with a multifunction display through which you will receive different pieces of information, such as the current TV transmitter and the interpreter of a piece of music.

The corresponding symbol will be illuminated on the display according to the application and the function being carried out.

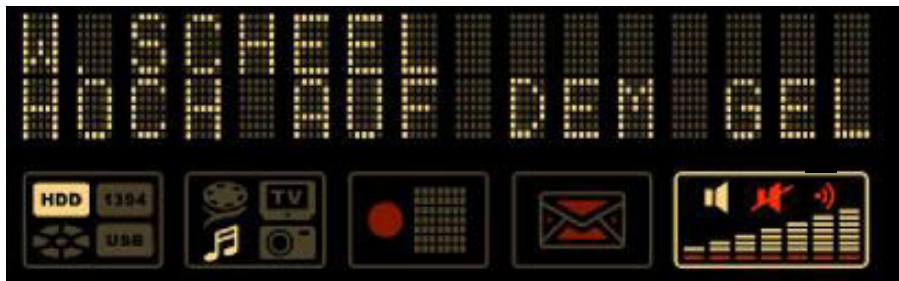

The date and the time are displayed in the delivery status. You open the configuration program, in order to make various settings, such as an individual signature text, by means of the  symbol to the right in the task strip.

# Multimedia at the press of a button

This PC is supplied with an additional multimedia function that will enable you to play photo slideshows, video DVDs, audio CDs or MP3 files by pressing a key, without having to start the Windows® operating system. Read how you can use this 'Linux Power Cinema' program in the following section.\*

## SWITCH POWER CINEMA ON

You will start the Linux Power Cinema application with the **multimedia button (N2)** when the PC is switched off. The user interface, which you will be able to operate with the aid of the remote of the multimedia keys, will appear after a short time.

## SWITCH POWER CINEMA OFF

It is possible to leave the application in three ways:

1. Press the On/Off switch (**N**) of the PC briefly.  
**or**
2. Press the On/Off button on the remote control.  
**or**
3. Select the 'Switch Off' menu point.

---

\* The card reader cards will not be supported here.

# The mouse

The mouse has beside the two key a wheel that can be used as:

To scroll through a document or internet pages.

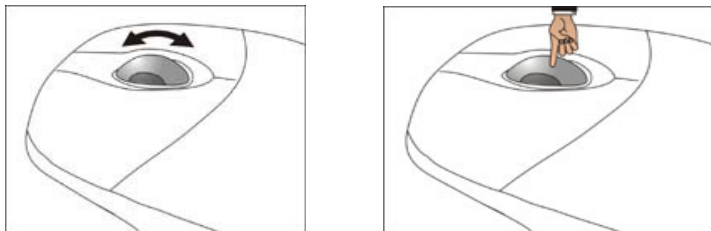

If the mouse course moves jerkily on the screen, try a different surface (mouse pad). Glass and metallic surfaces might cause problems.

## POWER-SAVING FUNCTION

You can activate the power-saving function of your mouse by **pressing both mouse buttons for longer**, if you do not wish to use your mouse for an extended period, for example if you have to do typing work for a long time. This serves to minimize battery consumption.

Hold **both mouse buttons pressed** down **at the same time** for several seconds, until the LED of the mouse switches on again, to switch the power-saving function off again.

# The keyboard

This section contains useful information on using the keyboard. All diagrams are **schematic**.

On the base of the keyboard are two folding feet that let you adjust the angle of the keyboard. Pull them forward to adjust the angle of the inclination.

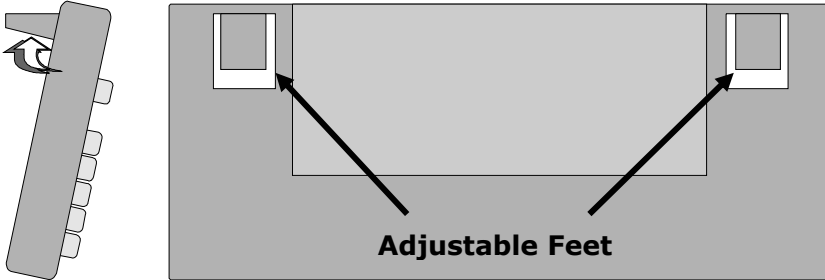

## THE ALT AND CTRL KEYS













The left **Alt** key performs certain functions in conjunction with other keys. The application program determines these functions. In order to enter a combination of keys that include the **Alt** key, hold the **Alt** key down while pressing the other key. The right **Alt** key operates in a similar way but selects certain special characters. The **Ctrl** key, like the **Alt** key, carries out program functions. Useful key combinations (software-dependent):







Key Combination	Function and Description
Alt + F4	As a rule ends the program selected or closes the window opened.
Alt + Print screen	Copies the image of the window currently active to the clipboard.
Shift + 2	Generates the @ character required for e-mails (pronounced: at).
Ctrl + Alt + Del	Windows security is launched.

(Country-specific variances are possible.)

## MULTIMEDIA FUNCTIONS

Some keyboards are provided with multimedia keys. These keys have the following functions:

Icon	Function
	<p><b>Standby Mode</b></p> <p>Depending on the settings in the computer's BIOS Setup or operating system the computer switches to standby mode.</p>
	<p><b>Back</b></p> <p>Switches to the previous web page/folder.</p>
	<p><b>Forward</b></p> <p>Switches to the next web page/folder.</p>
	<p><b>Cancel</b></p> <p>Stops a web page from loading.</p>
	<p><b>Refresh</b></p> <p>Refreshes the active window.</p>
	<p><b>Internet</b></p> <p>With this key you can start the standard Internet browser.</p>
	<p><b>E-Mail</b></p> <p>Use this key to start the standard e-mail program.</p>
	<p><b>Search</b></p> <p>Activates Windows default search function.</p>
	<p><b>Favourites</b></p> <p>Opens the folder „Favourites“.</p>
	<p><b>Multimedia</b></p> <p>Launches the multimedia application.</p>
	<p><b>Calculator</b></p> <p>Activates the Windows calculator.</p>
	<p><b>My Computer</b></p> <p>Opens "My computer".</p>

Icon	Function
	<p><b>Play/Pause</b></p> <p>Use this key to start or pause, for a short time, the playback of a track/title just as you would with a normal CD player.</p>
	<p><b>Previous Track</b></p> <p>Use this key to skip backwards to the previous track/title in the active player.</p>
	<p><b>Next Track</b></p> <p>Use this key to skip forward to the next track/title in the active player.</p>
	<p><b>Stop</b></p> <p>Use this key to end playback of the current track/title.</p>
	<p><b>Volume Control</b></p> <p>Increases/lowers the volume.</p>
	<p><b>Mute</b></p> <p>Switches the volume on/off.</p>



# The hard drive

The hard drive is the main storage medium combining large storage capacity and rapid data access.

The hard drive contains the operating system of the computer, other application programs and backup files. These programs and files are pre-installed on your PC, so you may note that some of the space on your hard drive is already taken.

The Windows operating system cannot use the full capacity of the hard drive, which means that there will be a difference between the capacity that the BIOS displays and what the operating system displays. The operating system of the PC, further application programs and backup files are located on the hard drive and reduce its total capacity.

The hard drive is addressed as drive C, D and E.



---

Never switch off the computer while the busy indicator is lit since this may result in loss of data.

---

Usually your hard disk is divided into more partitions, but there can also be some minor variations.

- In your first partition (**Boot**) you will find your operating system, application programs and the users' documents and settings.
- The second partition (**Backup**) serves for data security and contains additional drivers and tools.
- The third partition (**Recover**) contains the copies of your Windows-installation in the delivery state.

## IMPORTANT DIRECTORIES

In the following we listed the most important directories describing their contents.



---

**Attention!** Do not delete or modify these directories or their contents since data could be lost or the functionality of the system could be at risk.

---

**C:\** The master directory of drive C: includes important files required to start Windows. In the factory setting these files are hidden for safety reasons.

### **C:\Programs**

As the name suggests, in this directory programs install the files belonging to the application.

### **C:\Windows**

The main directory of Windows.

This is where the files of the operating system are saved.

### **C:\Documents and Settings**

This folder includes the settings and documents of all the PC users.

### **D:\Driver**

This folder includes the drivers required by your computer (pre-installed).

### **D:\Tools**

Here you find additional programs and other documentation for your PC.

### **E:\Recover**

Here the backup files are located enabling you to recover the factory setting (see page 81).

## CONNECTING AN EXTERNAL HARD DRIVE

Your PC has a so-called Databay, which will enable you to connect the external **MEDION HDDrive 2go** hard drive simply and without complications.

As in the case of a USB memory pen, connection takes place with a restarted operating system. The hard drive will be recognized as a replacement storage medium and will be allocated a drive letter automatically.



---

**Information:** Please pay take note of the fact that **only** the **MEDION Hard Drive** specified above can be connected to the Databay.

---



---

**Important!** Before using the databay, please remove the **protective caps**, which prevent the connectors from dust and other environmental effects. If you don't use the databay, please make sure that the protective caps are replaced.

---

# The optical drive

## LOADING A DISC:



---

**Attention:** Do not place protective foils or other stickers on your CD's. To avoid damage to your drive, do not use deformed or damaged CD's. Attention: Do not use scratched or dirty disks, discs with pieces broken off or disks of poor quality. Because of the high speeds in the drive the disks might break and damage your data as well as your drive. Examine the disks before you enter them. If damage or dirt is visible, you should not use them.

Damage caused by faulty media is excluded from warranty and their repair must be charged.

---

Diagram reference: **A**

1. Push the eject button (Diagram reference, **B**) on the right of the optical drive to open the tray.
2. Place the disc on the tray so that it lays flat with the label facing upward.
3. Push the eject button again to close the tray.



---

**Note:** Many CD's start automatically when they are inserted. This depends on the operating system and the corresponding settings.

---

## PLAYING BACK AND RETRIEVING DATA FROM DISCS

Your PC is able to playback and to retrieve Audio CDs, DVD Movies and Data discs.

After loading the disc your operating system will open a selection window with different options for playback.

If your operating system doesn't open the selection window you still have the possibility of the access via the explorer or "My Computer".

### HOW TO REMOVE A DISC:

1. Push the eject button (Diagram reference, B) at the front of the CD-ROM drive to open the drawer.
2. Remove the disc and store it in the CD cover in a safe place.



---

Do not try to remove the CD from the drive while the computer is accessing the disk.

---

### THE OPTICAL DRIVE AS BOOT DRIVE

The optical drives can be used for booting the operating system. If the PC does not boot, it is possible that **autostart** is turned off in the BIOS or the CD is not bootable.

## REGIONAL PLAYBACK INFORMATION FOR DVD

The playback of DVD movies includes the decoding of MPEG2 videos, digital AC3 audio data and the deciphering of CSS protected contents.

CSS (sometimes called copy guard) is the name of a data protection program incorporated by the movie industry as an action against illegal copies.

Among the numerous regulations for CSS licensees the most important ones are the country specific playback restrictions.

In order to facilitate the geographically restricted release of movies, DVD titles are released for certain regions.

Copyright laws require the restriction of each DVD movie to a certain region (usually the region, in which it is sold).

DVD movie versions can be published in several regions but the CSS regulations require that each CSS decipherable system may only be used in one region.



**Attention!** The decoding software included with your PC may be changed for regional DVD decoding up **to five times**, after which the drive will only play DVD movies for the region setting last entered. Changing the region code after that will require factory resetting which is **not** covered by warranty. If resetting is desired, shipping and resetting costs will be billed to the user.

---

## SUBJECTS CONCERNING THE CD/DVD-REWRITER

You receive information on the so-called **blank discs**.

These media, requiring a CD rewriter (burner) to produce CDs are called CD recordable (CD-R) or CD rewritable (CD-RW).

Recordable/Rewriteable Discs

Normal Discs are pressed from a digital, glass master and then sealed. In the case of blank disc, the information is burnt onto the disc with the laser of the Rewriter. Therefore these discs are more sensitive than normal CDs.

Please avoid the following when using recordable/rewriteable discs - especially blanks - that have never before been used:

- radiation by direct sunlight (UVA/UVB)
- scratches and damage to the disk surface
- extreme temperatures

### LIGHTSCRIBE

Your CD/DVD writer will support the LightScribe technology, according to the version. You will be able to provide the upper side of special CD or DVD media with a richly varied label with the appearance of screen printing, thanks to this new technology. The advantages demonstrate professional printing quality and simple handling in this case.

You need specially coated media to make a LightScribe disk. The corresponding software (Nero Burning ROM) and the installed CD/DVD writer support the LightScribe technology completely.

# The card reader

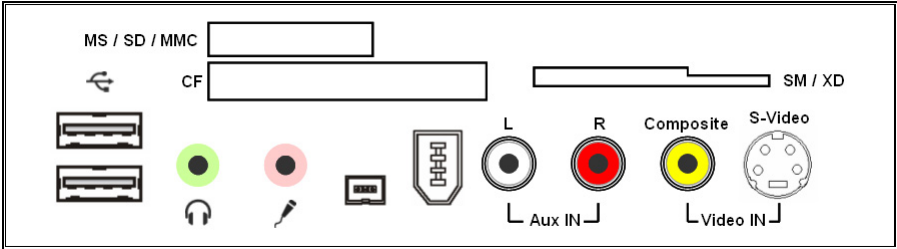

You can handle different memory card types.

The following table refers to the use of the Card Reader:

Slot	Card type	Contacts
MS SD MC	Memory Stick Memory Stick Pro SD (Secure Digital) MMC (MultiMediaCard)	point to bottom
CF	CF (Compact Flash) IBM® Microdrive	point to front
SM/XD	SmartMedia / XD	point to bottom

If a card is inserted, a free drive will be assigned\* by Windows®.

\* Only if this concerns a removable disk.



# The graphics card

Your computer is fitted with a high performance graphics card, one of the most technologically advanced and best-equipped VGA cards available.

## PERFORMANCE CHARACTERISTICS

- High Performance Acceleration
- Interactive Direct3D Acceleration
- Video Acceleration for DirectDraw/DirectVideo, MPEG-1, MPEG-2, DVD and Indeo<sup>®</sup> Video Technology
- ACPI Power Management

## CURRENT IMAGE PLAYBACK FREQUENCIES

The graphic card can, depending on the set resolution, display vertical image playback frequencies of between 60 Hz and 240 Hz.

Resolution	Colors	Resolution	Colors
640 x 480	8-, 16-, 32-bit	1600 x 900	8-, 16-, 32-bit
800 x 600	8-, 16-, 32-bit	1600 x 1200	8-, 16-, 32-bit
1024 x 768	8-, 16-, 32-bit	1920 x 1080	8-, 16-, 32-bit
1152 x 864	8-, 16-, 32-bit	1920 x 1200	8-, 16-, 32-bit
1280 x 960	8-, 16-, 32-bit	1920 x 1440	8-, 16-, 32-bit
1280 x 1024	8-, 16-, 32-bit	2048 x 1536	8-, 16-, 32-bit

You can change the graphics setting using the **Display Properties** help program. For optimum image reproduction we recommend an image playback frequency of between 75 Hz and 85 Hz, provided that your monitor can support this. An image playback frequency of less than 70 Hz will generate a flickering image, unless an LCD monitor is being used.

## CONNECTING THE PC TO A TELEVISION

With the help of the video output connectors (TV-out) at the back of your PC, you can transfer the image from your PC to the television set.

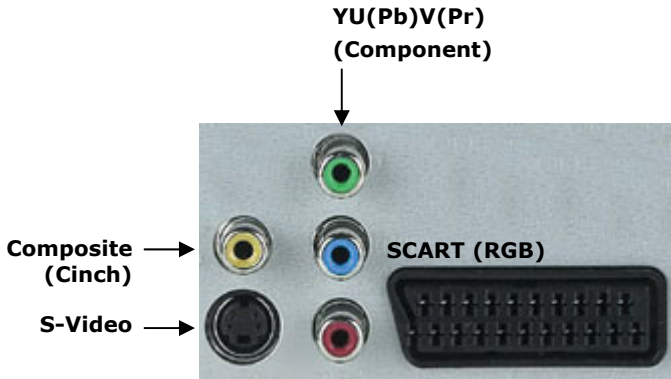

---

In order to connect your TV to the PC you will need a SCART cable, an S-Video cable, a composite video cable or a component cable. This cable is **not** included with your computer but may be obtained from an audio/video specialist or dealer. Read the operating instructions for your television set to find out which cable you need.

---

## HOW TO CONNECT THE PC TO A TELEVISION:



---

To use the TV function you must **first connect** the TV to the graphics card **before starting** up the PC.

---

1. Shut down Windows and power off the PC.
2. Connect an S-Video, a SCART, a Composite, or a Component cable to the respective connector of your PC (reference **V/V2/V3/V4**) and to your TV set.
3. Switch on the television to see the PC image on your TV set.
4. Start up the PC and wait for Windows to fully load.
5. In the **Display Properties** program set up the configuration.
6. End configuration by clicking on **OK**.



---

The Video Output connectors at the **back** of you PC are only for **playback**. For **video recording** please use the Video Input (composite or S-Video) connectors at the **front** of your PC.

---

# The sound card

Your PC has an integrated Intel® High Definition Audio Sound chip.

This guarantees optimal support for all popular programs and games.

---

 **Note:** The speaker/headphones output is designed for active speaker systems or headphones. Passive speakers cannot be used or if they are the quality will be significantly reduced.

---

You can make the necessary settings for configuring the loudspeakers, etc. by means of the software supplied with the PC. You open the configuration program, to make user-defined settings, by means of the  symbol on the right in the task strip.

# USB port



---

**Note:** Devices connected directly to the USB bus should not draw more than 500 mA.

The voltage output is protected by a fuse (Limited Power Source according to EN 60950).

Should the devices need more power than this, it will be necessary to provide a hub (distributor / booster).

---

On the USB it is possible to connect up to 127 devices which correspond to the USB standard (1.1 and 2.0 supported).

The data transfer speed is 1.5 Mbit or 12 Mbit, depending on the device connected. USB 2.0 can reach up to 480 Mbit.



---

**Note:** If possible, connect your USB devices always to the same port where it has been installed. Otherwise you will get a new ID and your operating system asks for a new installation of the driver.

---

# IEEE 1394 (Fire Wire)

The IEEE 1394 connector, also known as iLink® or Fire Wire, is a serial bus standard used for rapid digital data exchange.

## APPLICATION OPTIONS FOR IEEE1394

- Connection of digital devices of the entertainment industry, such as set-top speakers, digital video and camcorder, 'Digital Versatile Disk' (DVD), television etc.
- Multimedia applications and video processing.
- Input and output devices such as printers, scanners, etc.

## TECHNICAL SPECIFICATIONS

- Depending on the application, the maximum data transfer is about 100, 200 or 400 Mbit/s, corresponding to a data throughput of up to 50 MB per second.
- The device can be plugged in or unplugged during operation (hot plugging).
- The standardised cord ('Shielded Twisted Pair' –STP) includes 6 strands. Two lines are live (8V up to 40V, 1.5 A max.) and can be used as an external power supply. The four signal lines transfer data or control information. Some devices do not require a power supply via the cord so that four pole plugs are use.
- The voltage output of the 6-pole IEEE 1394 jack is protected by a fuse (limited power source according to EN60950).



---

**Note:** The IEEE 1394 ports located **at the front** of you PC can only be used separately. A simultaneous use is not possible.

---

# The TV tuner card

## WATCH TV

The Software to watch TV is already installed and can be found in **All Programs, Home Cinema**. You can control the program with the remote control (see Online help and/or separate Operating Instructions). Get additional help by pressing the F1 Key.

Start a program scan to set your programs by selecting **Settings** ⇒ **Autoscan**.

The software is coordinated to the installed TV tuner card and the delivered motherboard. Other hardware combination may lead to malfunctions.



---

**Note:** please keep in mind that recording broadcasts can occupy up to 2.4 GB per hour. Save data which you don't need permanently on external media or swap them to the D: drive.

---

## THE DUAL TUNER FUNCTIONS

The TV card supplied with your PC is both a dual analogue/DVB-T and a dual DVB-S tuner.

You can choose between two connection possibilities by means of the switch on the card. It will be necessary to remove the left side wall of the PC casing to do this.



---

**Caution:** Pay attention to the safety information from page 25 under all circumstances! There will be **mortal danger** because of electrical shock if the PC is not detached from the electricity network before opening it. There will also be the danger that components could be damaged. Never switch on an open computer!

Only carry out work with electronic components at an **ESD work space**. Wear **antistatic protection** or maintain contact with a highly conductive metal object, if such as work space is not available.

---

### SWITCH POSITION 1 (OPERATION WITH ONE ANTENNA)

This setting is the **status at delivery**. Connect **one** antenna cable to the **Y2** main connection exclusively, to receive DVB-T **or** analogue (e.g. cable) television. You will be able to receive two channels at the same time with one cable. Use this setting if you **only** have **one** antenna.

### SWITCH POSITION 2 (OPERATION WITH TWO ANTENNAS)

The TV card must be set at Position **2**, in order to be able to use this function. This change will only be necessary if you wish to used digital terrestrial (DVB-T) and analogue (DVB-T) **at the same time**. Both antennas (**Y** and **Y2**) must be connected, to enable use of both at the same time.



The following table shows the possible combinations:

Switch position	TV antenna 1 (connector <b>Y2</b> )	TV antenna 2 (connector <b>Y</b> )
1	DVB-T	-
1	Analogue	-
1	2 x DVB-T*	-
1	2 x Analogue*	-
2	DVB-T	Analogue
2	Analogue	DVB-T

\* Dual function, to be set by means of the software supplied with the computer.

The function of the DVB-S connections (**Y3** and **Y4**) depends on the position of the switch on the TV card.

You will be able to use 2 signals at the same time, independently of the TV signals received at the time.

# The remote control



---

**Note:** This wireless remote control set can only be used to control the **Power Cinema** program on your PC. In order for it to work, the following conditions must be met:











- The PC must be booted up.
  - Windows®XP must be fully loaded.
  - The driver software must be installed\*.
  - Power Cinema installed\*.
- 

\* All these conditions are met in the delivered state.

## INSERTING BATTERIES

1. Turn the remote controller upside down.
2. Open the battery compartment by carefully pulling the clip on the cover and lifting it at the same time.
3. Insert two batteries (type: AAA, Micro) in the battery compartment. Ensure that the polarity corresponds to the illustration etched on the inside of the battery compartment (+ must correspond with + and - with -).
4. Close the battery compartment again.











## BUTTON LAYOUT

		On / Off
		View television programs.
		Record television programs.
		Open photo archive.
		Open music archive.
		Open DVD menu.
		View video recordings.
		EPG function (Electronic Program Guide)
		Start video text application.



**Note:** The functions described here are standard functions.

These Buttons can differ according to the operating mode (TV, video, photo, etc.).

		 <p>Special function Button (e.g.: Selection of the audio track) In full screen mode the menu for audio setting pops up.</p>
		 <p>Special function Button (e.g.: Camera selection) In full screen mode the menu for primary tuner setting pops up.</p>
		 <p>Special function Button (e.g.: Chapter selection) In full screen mode the channel list pops up.</p>
	<p>Special function Button (e.g.: Subtitle selection) In full screen mode the you can select the twinTV tuner.</p>	
	<p>You select the required function with these navigation Buttons. The selection indicator will move in the appropriate direction. <b>Press</b> the OK button to confirm your selection.</p>	
	<p>Press + to increase the volume. Press - to lower the volume.</p>	
	<p>Mute Switch (Switches the sound output off).</p>	
	<p>Press + to select the next channel (TV). You select the previous channel with -.</p>	

		Reverts to the point selected previously.
		Application-related information function.
		The <b>Select</b> button lights up if a button on the remote is operated. It serves to select certain functions, i.e. for the changing of the transmission / reception channel of the remote.
		Rewind
		Starts playback.
		Fast forward
	Pauses the playback at the selected point.	
	Previous title/images	
	Next title/images	
	Ends the playback/recording	
	Start recording	
	<p>Direct selection of the TV channels by means of numbers. Number entry in the case of some functions (video text, etc.).</p> <p>With the * button you can switch from user interface to full screen mode.</p>	

## CHANGING THE TRANSMISSION/RECEPTION CHANNELS

If several computers with remote controls are set up in close proximity of each other (approx. 10 metres), this can lead to disturbance. This can be remedied by choosing different channels.

**Only reset the remote control in case of disturbances.**

Proceed as follows:

1. Start the program **Power Cinema** in the program folder **Home Cinema**.
2. Choose the menu item **Settings** and in the following screen **Set Remote Control Channel**.
3. Reset the **new channel** (a number between 1 and 16) in the software initially and confirm your setting with the **OK key**. You will be passed on to the Channel Change option of the remote automatically.
4. Press and hold the **select** button until the LED starts flashing.
5. Now enter the **new channel** for the remote and confirm with the **OK key**.
6. Close the Channel Change option by pressing the **select** button.

# The network

Your PC is provided with a Fast Ethernet-Network connector. You will find further information about networking in the **Help** section within the **Start** menu.

## WHAT IS A NETWORK?

A network means connecting your PC to another or several other PCs. Users can transfer information and data between computers and share resources such as printers, modems and hard disk drives.

Here are some practical examples:

- You can exchange Email and manage appointments in an office.
- Users share a printer in a network and save their data on a central server.
- Share one modem or one ISDN card among computers for Internet access.
- Two or more PCs can be connected to play network games or share data.

# WIRELESS LAN

This function allows you to create a wireless network link with a partner.

## SAFETY NOTES



---

**Attention:** Don't use this feature in environments where highly sensitive devices are placed such as in hospitals etc.. To avoid any interference disable this option in your device manager.

---

## CONDITIONS

The partner used can be a wireless **access point**. An access point is a wireless transmitter that communicates with your notebook and controls access to the network connection (e.g., a home network or a broadband connection such as DSL).

Wireless access points are often found in offices, airports, universities or Internet cafés. They offer access to enterprise services and networks or to the Internet. **Access authorizations** are normally needed. A fee may be required to use a public access point.

To set up a wireless network to share Internet access, files, and printers at home, you will need an access point, a router, and a broadband (DSL or cable) modem. Some access points can also serve as a router and/or a broadband modem. Check with your retailer to find the best solution for your needs.

A link to another computer with wireless LAN functionality can also be created **without an access point**. This will allow you to share files, but you will need an access point and a router to share an Internet connection.









The wireless network link works according to standard **IEEE 802.11g** and is compatible to the standard **IEEE 802.11b**. Other standards (802.11a etc.) are not supported.

If encrypted transmission is used, this must operate according to the **same principle on all devices**. Encryption is a method of protecting the network from unauthorized access.



The transmission speed (max. 54 Mbps) can vary according to distance and other factors. If i.e. the other devices support the 802.11b standard the transmission speed can be max. 11 Mbps. Search for "wireless networking" in Windows Help and Support for more information.

## TROUBLESHOOTING WITHIN THE NETWORK

-  Why does the network environment not show the releases?
-  The network environment is delayed in time. Check the release by searching for the respective **computer name**.
-  Why does an error message appear when I click on the network environment?
-  The **computer name** must be unique on the network and may not be the same as the **task group**.
-  It appears that the network boards are unable to communicate. What might be the problem?
-  Maybe one of the used network boards works with a **different speed** (e. g. 10 instead 100 Mbit) and your network computer is unable to recognize this. If necessary, set the network driver to the compatible speed.  
If two PCs should be linked you require a **cross-link cable**, otherwise use a **patch** cable.  
In addition, check the **protocols** and the **configuration**.
-  The data transmission is incorrect or very slow. What might be the problem?
-  Maybe you have the wrong cable (UTP / CAT3 or lower) or the problem is the proximity of a power cord or another source of interference.

For further hints on troubleshooting refer to the Windows help under "**Network errors**".

# Modem / ISDN

This chapter is intended for systems equipped with a modem or ISDN jack.

The built-in modem is able to receive data according to the ITU standard for V.90 transmissions with up 56 Kbit/s.

Since the power output of modems is restricted due to the regulations of some telecommunication providers, the possible maximum download speed can be restricted. The actual speed may be dependent on the online conditions and other factors.

Data sent from the user to the server are transmitted with 31.2 Kbit/s. Prerequisite for this high speed reception is an analogue telephone line compatible with the V.90 standard and a corresponding compatible Internet provider or company-owned host computer.

Contrary to the modem, **ISDN** data are transmitted digitally.

The modem is fitted with an RJ-11 interface, into which a standard telephone lead can be plugged. If your modem is a combo card please make sure that it is used only with the appropriate port.



---

**Warning!** Use only analogue telephone sockets. The modem cannot withstand the voltage levels of digital telephone systems such PABX or lines such as ISDN or Broadband services

---

## Serial COM port

The **optional** 9-pin serial interface is used as the port for serial devices such as modems, card readers or mice. The interfaces are addressed as **COM1** or **COM2** and are FIFO 16550-compatible. To use these ports it is necessary, as standard, to have a so-called null-modem cable which is usually supplied with the device to be connected.

# Software

This section deals with software, differentiating between **BIOS**, **application programs** and **operating systems**.

## GETTING TO KNOW WINDOWS<sup>XP</sup>

Windows XP offers different options to understand its operation. We will mention only a few of those options here:

### WINDOWS<sup>XP</sup> HOME EDITION – FIRST STEPS

This manual will provide general information about the operating system. We recommend that all beginning users or users of previous versions of Windows read this information.

### WINDOWS<sup>XP</sup> HELP AND SUPPORT

An answer to almost every question can be found in this program. You'll find it in the Start menu or you can launch it by simply pressing the F1 key.

This help function fully covers the Windows operating system.

It is helpful for both beginners and professionals. You can print or bookmark the information, which is categorized into topics. You start like this:

1. Click on



2. Select now



## MICROSOFT INTERACTIVE TRAINING

To obtain an overview over the functions and the operations of Windows<sup>XP</sup> we **recommend** the program „Windows<sup>XP</sup> Interactive Training“.

The objective of the program is to ease both the initial contact with and the transition to Windows<sup>XP</sup> for beginners and experienced users.

The program is categorized into many small topics, so that the user can gain access to the information according to his requirements. Multimedia effects including video clips and speech output convey the contents of the various topics clearly and efficiently.

Interactive tasks allow you to apply the conveyed topics in a simulation environment of the program to facilitate a successful learning experience.

Windows XP Step by Step Interactive covers ...

- operating Windows<sup>XP</sup>
- new functions in Windows<sup>XP</sup>
- the process of log-on log-off and user administration for creating a security structure
- configuration of the Internet access
- operating the email program
- ... and much more!

Use this program to better understand your PC and to operate it optimally. It also is an additional source of information for recognizing and eradicating potential problems. You start the program like this:

1. Click on 
2. Select now **All Programs** 
3. The program is located in the folder "**Accessories**", subfolder „**Microsoft Interactive Training**“.

## WRITING CDs/DVDs

We describe the writing process with the software **Nero**. Please follow this instruction only if you use this software.



---

 **Note:** A writing process should always take place on its own. Please terminate all running programs (fax reception, screen savers, Power-Management etc.).

---

### STARTING NERO - EXPRESS

To start Nero - Express proceed as follows:

1. Click 
2. Now select 
3. The program is located in the "**Nero**" folder under "**Nero OEM**" and can be started by clicking "**Nero - Express**".
4. An interface appears that allows you to easily create different media. Follow the instructions on the screen.

---

 **Note:** The Nero - Burning ROM program has enhanced functions and is particularly suitable for the more experienced user. You can also start this program from the Nero folder or switch directly to it from the Express program.

For detailed information, read the extensive On-line Help (F1 key).

---

## INSTALLATION OF SOFTWARE

**Note:** If your operating system is configured that the installation procedure accepts only signed drivers (default) and software this information screen will appear:



Although the software lacks the digital signature it may work properly. Click on "Tell me why this testing is important" to get detailed information. Confirm by clicking on "**Continue Anyway**".

The software included in delivery is **already pre-installed** in the factory.





**Attention!** It happens that during installation procedure important files can be changed or even cancelled. To avoid eventual problems in using older files after installation, make sure to safeguard your hard disk. See page 77 for further information regarding data backup.

## THIS IS HOW TO INSTALL YOUR SOFTWARE:

Please follow the instruction of the software vendor. We will describe a typical installation. Once you insert a CD, the installation menu is started automatically.

 **Note:** If the automatic start does not work, it is likely that the so-called **Autorun** function has been deactivated. Read the respective chapter in Windows Help on how to activate this function.

An example for the manual installation without the autorun function:

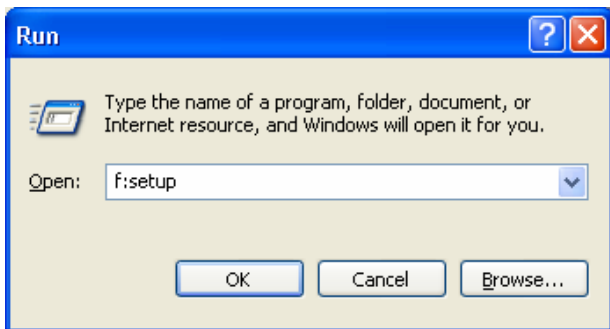

1. Click on  and select the item  (or hit  + R to launch the corresponding dialog).
2. Now enter the letter of the CD-ROM drive followed by a colon and the program name setup:



3. Click on **"OK"**.
4. Follow the instruction given by the program.

## SOFTWARE UNINSTALLATION

In order to remove installed software from your PC, follow the next steps:

1. Click on 
2. Click on 
3. Then select the following program:



4. Select the respective program, start the uninstallation and follow the instructions on the screen.



## WINDOWS ACTIVATION

Microsoft is committed to the protection of intellectual property rights and the reduction of software piracy. Therefore Windows XP contains software-based product activation technology. Your copy of Windows XP has already been **activated for your PC**.

Product activation is needed if some components of your PC have been replaced or you use a non-authorized BIOS. If necessary you can activate Windows XP as often as requested.

You will probably need to activate Windows XP by telephone even if Internet Activation is available. This is due to the pre-activated SLP version which runs with a special Product-ID. However, activation needs your unique Product ID which can be found on the **Certificate of Authenticity** sticker on your PC housing. When you call, please inform your agent that you are running an OEM-(SLP) version of the software.

## PRODUCT ACTIVATION ON YOUR PC

In few cases it may still be required to activate Windows<sup>XP</sup>. If an activation via the **internet** is acknowledged with an error message you should perform the following steps.

1. Please select the **telephone activation** and click until the related screen appears.
2. Now click on **Change Product Key**. A new window appears. Enter the product key. This is located on the **Certificated of Authenticity (COA)**, on the computer's casing.
3. Acknowledge your entry and follow the instructions on the screen. Notify your Microsoft consultant, if necessary, that you have an OEM license.

## BIOS SETUP

In the BIOS set up (your PC's Basic Configuration) you have a number of parameter settings available for your PC. For example, you can change the operating mode of the interfaces, security features or power management.



---

The PC is factory pre-set to guarantee optimum operation. Please only modify the parameters if this is absolutely essential and if you are familiar with the configuration possibilities.

---

## EXECUTION OF THE BIOS SETUP

You can only execute the configuration program when starting the system. If the PC has already been started exit Windows® and reboot. Prior to rebooting the PC press the key "**DEL**" and keep it pressed until the message "**Entering Setup**" appears.

# Chapter 4

## Customer service & self help

<b>Subject</b>	<b>Page</b>
Data and system security .....	77
System recovery .....	78
FAQ – Frequently Asked Questions .....	83
Troubleshooting .....	85
Driver support .....	87
Transport .....	88
Cleaning and care .....	88
Recycling and disposal .....	89
Upgrades and repairs .....	91



# Data and system security

The programs described below are part of your Windows operating system. You will find additional information on these programs in the Windows Help file.

## DATA SECURITY

Back up data regularly on external media such as a CD-R or CD-RW. Windows offers both a **Backup** program and a **Files and Settings Transfer Wizard**.

You will find both programs in **Accessories** ⇨ **System Tools** within the Start menu. Make a backup disk with all your passwords and the operating system's original configuration.

## MAINTENANCE PROGRAMS

You can avoid some hardware and software errors with the help programs such as **Disk Defragmenter** and **Disk Cleanup**. The help program **System Information** can also be helpful since it gives you detailed information about your system configuration. You will find these programs in **Accessories** ⇨ **System Tools** too.

## PASSWORD RESET FILE

To protect individual user accounts from complications resulting from lost passwords, users should create a password reset disk and keep it in a safe place. If the user should forget his/her password, the password can be reset with the password reset disk so that the user has access again to his/her local user account. Windows Help describes how to create a password reset file.

# System recovery

Windows<sup>XP</sup> provides a useful function enabling the storage of the so-called **Recovery points**.

The system remembers the current configuration as a snapshot and returns to this, if necessary. The advantage is that an unsuccessful installation can be cancelled.

**Recovery points** are created automatically by the system, but they can also be set manually.

You can determine and configure yourself the maximum memory taken up by this. You find this program in the program file under **Accessories** ⇒ **System Tools**.

We recommend setting a **recovery point** before installing a new software or driver. If the system does not run stable any longer this enables you usually to return to a workable configuration without deleting newly created documents. In the next paragraph read your options for a repair of an incorrect installation.

## CORRECTION

Windows<sup>XP</sup> includes various functions ensuring that the PC as well as the installed applications and devices work correctly.

These functions assist you in solving the problems which might occur by adding, deleting or replacing files required for the functionality of the operating system, the applications and devices. The recovery function or functions you use depend on the type of occurring problem or error. For detailed information refer to the Windows help.

Enter the search word "**Repair overview**" in order to evaluate which of the following functions is the safest way to correct your problem:

Backup, Recovery of the driver, Deactivation of the device, System recovery, Last function known to work, Secured mode and system recovery, Recovery console, Windows installation CD.

Please refer to the tool.

## WINDOWS® UPDATE

**Windows Update** is the online updating of Windows. Use Windows Update to download elements such as security updates, important updates, the newest help files, drivers and Internet products from the Internet.

The website is regularly augmented by new content, so that you can download the newest updates and error corrections at any time, to protect the Notebook and guarantee its functioning.

Windows Update will search through the Notebook and provide a list of individual updates especially for the configuration of your Notebook.

Each update that Microsoft regards as important for the operation of the operating system, programs or hardware components will be classified as an "important update" and automatically selected for installation for you.

Important updates will be provided to remove known problems and to protect the Notebook against known security risks.

Carry out four simple steps, to download the updates needed and to keep your computer on the current status of technology:

1. Open **Windows Update** in the Help and Support Center.
2. Click on **Search for update**.
3. Click on **Add** to select the desired update and to add it to the updates to be installed, while you are searching through the available updates in each category. You can also read a complete description of each individual element by clicking on the **Read further** Link.
4. Click on **Check and install updates**, when you have selected all the desired updates, and then click on **Install now**.

## **WINDOWS UPDATE INFORMATION FOR DATA SECURITY**

Windows Update needs certain information about the respective Notebook, so that a suitable list with updates can be provided for you. This information will include the following:

- Version number of the operating system
- Version number of Internet Explorer
- Version numbers of additional software programs
- Plug & Play identification key of the hardware devices

Windows Update will stand up for the protection of your private data and will not record your name, address, email address or other forms of personal data. The information collected will only be used during the time that you are visiting the website. It will also not be stored.

The update can only be executed via the Internet. Ensure that you are on-line with your PC when downloading the updates.



## RESTORING THE FACTORY SETTINGS



Should your system not function correctly, you have the opportunity to recover the original set-up.

Use the included application/support disk to do this. This recovery method offers you several possibilities for system recovery:

### **System recovery from hard disk**

1. Rebuild start files
2. Rebuild system and driver files
3. Return to shipping status

### **LIMITS OF THE RECOVERY**

- Changes made to the original configuration (RAS, Desktop or Internet settings) and installed Software will be ignored by this Recovery and will not be reloaded.
- Driver Updates or hardware installed by you will be ignored by this Recovery.



---

**Beware!** All data on drive C will be erased. If necessary, backup all required data on drive D.

---

This recovery will reset your system to its condition at delivery. Printer installations or other additional software must be reinstalled. You will also need to enter the **Product Key** (License Number) again.



**Attention!** If you delete the directory **E:\Recover** or the files located there a recovery is no longer possible. For safety reasons you can copy the file **FACTORY.PQI** and all other **FACTORY.00X** files to a CD-Recordable.

---

## CARRYING OUT A RESTORE

1. First, please read the entire **Restore** section of the Windows Help file.
2. Insert the Support-CD and reboot the PC.



**Attention!** Do not use the **Product Recovery CD-ROM** for restoration purposes. This disk does not restore the original set-up. You can use it when an individual set up is required.

---

3. Select the option **Start from CD-ROM**.
4. Follow the on-screen instructions.
5. The PC restarts to its original factory settings.

# FAQ – Frequently Asked Questions



When do I have to activate Windows?



Your software has been preactivated in the factory. An activation will only be required, if ...

... several components are replaced by others.

... you install a new motherboard.

... a different BIOS version has been installed.

... you install the software to another computer.



What is the Windows activation?



Your operating instructions include a chapter about this subject.



How do I perform a data backup?



Use the program Backup for this.

It is important that you follow the operating instructions of this program.

Make a backup and another backup of selected data to an external medium (CD-R), to familiarise yourself with the technique.

A backup is unsuitable if you are not able to recover the data, the medium (CD-R, CD-RW) is defective or no longer available.



Do I still have to install the enclosed CDs/DVDs?



No. Basically all programs are already preinstalled. The disks are only intended as backup copies.



When is the recovery of the factory setting recommended?



This method should be chosen as the last resort. Read chapter "**System recovery**" on page 78 concerning the alternatives possible.



Why is the boot partition missing when booting from the support/ application CD?



The first partition is formatted with the file system NTFS. Compared to FAT32 this file system offers more security and a more efficient access. However, NTFS partitions can only be read from operating systems supporting this. This is not the case in the aforementioned CD.

# Customer service

## TROUBLESHOOTING

Errors can have simple causes, but sometimes they are caused by faulty equipment. We would like to give you some ideas to solve common problems. Should these instructions not lead to success, please feel free to call us.

## LOCALISE THE CAUSE

Visibly check all cables and connections. Should all lights be off, check whether all equipment is supplied with power.

- Check power points, power cable and all power switches.
- Switch off the PC and check all cable connections. Check the connections to peripherals. Do not exchange cables, even though they may look similar. The polarity in those cables may be different. When it is confirmed that the computer has power and all connections are correct, turn the computer on again.

Frequent use of the programs **Disk Defragmenter** and **Disk Cleanup** will help you to avoid problems with your operating system.

The tool "**System Information**", available in the program folder "**System Tools**" is also very useful.

## **ERRORS AND POSSIBLE CAUSES**

### **The monitor is blank.**

- Confirm that the system is not in stand-by mode. Press any key on the keyboard to test this out.

### **Wrong Date and Time:**

- Double-click the clock on the taskbar and correct the date and time.

### **After a system restart a new drive letter is assigned to the cards in the card slots.**

- This can happen, when the card reader re-initializes the slots during a system start. New IDs might be assigned, which can lead to new drive letters for some cards.

### **No data can be accessed from the optical Drive.**

- Check whether the disc is inserted correctly.
- Is the optical drive (Drive E) displayed in Windows Explorer? If so, test another disc.

### **The mouse does not work.**

- Check the cable.
- Does your mouse work with other programs? Is your mouse activated?
- Check the batteries. If they are empty change them by using batteries of the same type.

### **There is not enough room on the HDD.**

- Audio and video recording require a lot of storage capacity (up to 2.4 GB / hour). Back up unnecessary files of "**My Documents**" onto CD-R's or move them to drive D:.

### **The PC does not start up.**

- If all cable connections are correct, then try to reset the power supply of the PC. Set the power switch at the rear of the PC to position 0 (OFF). Now press down the main switch at the front of the PC for 10 seconds. Wait 5 more seconds and the restart the PC.

## ADDITIONAL SUPPORT

If the suggestions in the above section have not solved your problem, please contact the service hotline and we will attempt to help you solve the problem. Before you contact the Technology Centre, however, please have the following information available:

- How is your computer configured?
- What additional peripherals do you use?
- What messages, if any, appear on your screen?
- What software were you using when the error occurred?
- What steps have you already undertaken to solve the problem?
- Have you upgraded or removed drivers or hardware?
- Can you manually repeat the problem?
- If you have been given a customer number previously, please quote this.

## DRIVER SUPPORT

This PC has been extensively tested in our laboratories with a large number of compatible devices. It fulfils all required standards and complies with the standard "Designed for Windows", which certifies utmost compatibility.

However, often the software drivers for individual components are updated from time to time. This is a regular process provided by the manufacturer to mend possible compatibility problems that may occur with components (e.g., programs or hardware) that were not tested at the time of your PC's manufacture. Driver updates and the latest information on your product are available on the Internet.

Visit Medion on the Web at **[www.medion.com](http://www.medion.com)**

## TRANSPORTING THE PC

Please observe the following guidelines when transporting the PC: To avoid damage during transport, store the PC in its original packaging.

## CLEANING AND CARE

The lifetime of the PC can be extended by taking the following measures:



---

**Warning!** There are no user-serviceable or user-cleanable parts inside the PC housing.

---

- Before cleaning, **always remove the power** plug and all connecting cables.
- Clean the PC with a damp, lint-free cloth. **Do not use any solvents, corrosive or gaseous cleaning agents.**
- **DO NOT use CD-ROM cleaning disks or similar products that clean the lens of the laser to clean your CD-ROM/CDR-W/DVD-drive.**
- The **shiny surface** of your PC is very delicate; it is recommended only to clean it with a **soft cloth** for this reason, in order to avoid **scratches**.



## RECYCLING AND DISPOSAL

This PC and its packaging was produced mostly from materials which can be disposed of in an environmentally friendly manner and be professionally recycled.

After its use the computer will be taken back and recycled or use will be made of its useful material, if it is returned in a condition corresponding to its intended use.

Parts not usable will be properly disposed of.

---

 **Attention!** There is a lithium battery on the motherboard. No type of battery belongs in the household waste. All are taken back free of charge by the manufacturer, dealer or their representatives for a proper method of utilisation or disposal.

---

Should you have any questions concerning the disposal please contact your dealer or our service.

## BATTERY TREATMENT

Batteries may contain combustible materials. By misuse, this may cause battery **leakage, heat, explosion** or **ignition**, bringing about **injury** or **damage** to the device.

Please observe strictly the following matters:

- **KEEP CHILDREN AWAY** from batteries.  
If by any chance, the batteries are swallowed, consult a doctor immediately.
- **DO NOT CHARGE** batteries (except rechargeable batteries).
- **DO NOT FORCIBLY DISCHARGE** batteries.
- **DO NOT SHORT-CIRCUIT** batteries.
- **DO NOT HEAT** or **DISPOSE OF IN FIRE**.
- **DO NOT DISASSEMBLE** or **DEFORM** batteries.  
Your hands and fingers may be injured, or the liquid of the battery may get into your eyes or adhere to your skin. If this happens, rinse with a large quantity of water immediately and consult a doctor.
- **DO NOT** expose batteries to **strong impact** by dropping or throwing the batteries.

- **DO NOT reverse** the positive (+) and negative (-) **terminals** to avoid short-circuit.
- **Do NOT MIX** used and new or different types of batteries together.  
Your equipment may not operate properly. In addition, the battery exhausted first may be excessively drained (over-discharged).
- **REMOVE PROMPTLY** the **used batteries** from the device.
- **REPLACE ALL BATTERIES** with new batteries of the same type at the same time.
- **INSULATE THE TERMINAL** parts with tape or the like at the **storage or disposal** of the batteries.
- **DO NOT throw** rundown batteries in the domestic refuses! Respect the environment and throw them in the specific containers for separate collection. If necessary, turn to your reseller or to our service assistance. Thank you!



## UPGRADES AND REPAIRS

- Only a qualified engineer should perform upgrades and repairs to your PC.
- If you do not have the necessary qualifications, go to an appropriate **Service Engineer**. Please contact our **Service Centre** if you are experiencing technical problems with your PC.

## NOTES FOR SERVICE ENGINEERS

- Before opening the housing, **disconnect the PC from all power sources and remove any connecting cables**. If the PC has not been disconnected from the power outlet before being opened, there is a **danger to life** through electric shock. There is also a risk of damage to the components.
- Internal components of the PC may be damaged by **electrostatic discharge (ESD)**. Carry out system upgrades and changes in an **ESD-protected workshop**. If no such workshop is available, wear an **antistatic wrist strap** or touch a highly conductive metal object. Medion can repair damage sustained by inappropriate handling for a fee.
- Use only **original spare parts**.



---

**Caution:** Lithium batteries can not handle intense pressure, high temperatures or fire. Danger of explosion if replaced incorrectly. Replace batteries with a compatible type as recommended by the manufacturer.

Lithium batteries are hazardous waste and require proper disposal. Contact the Service Centre for additional information on battery disposal.

---

## Notes on Laser Radiation:

- Laser devices of Laser Class 1 to Laser Class 3b may be used in the PC. Where the PC housing remains closed, the device meets the requirements of **Laser Class 1**. By opening the PC housing you will gain access to laser devices of up to Laser Class 3b.
- The CD-ROM-/CDRW-/DVD-drives installed contain **no user-serviceable** parts.

When removing and/or opening laser devices, the following guidelines must be observed:

- Only the **manufacturer** should perform repairs to the CD-ROM-/CDRW-/DVD-drives.
- **DO NOT look into the laser beam**, even while wearing optical protection.
- **DO NOT allow yourself to be exposed to the laser beam**. Avoid exposure of the eyes or skin to direct or stray radiation.

# Chapter 5

---

## Appendix

<b>Subject</b>	<b>Page</b>
PowerCinema Linux license agreement .....	95
Standards .....	96
Warranty .....	100
Index.....	102



# PowerCinema Linux license agreement

## LICENSE DISCLAIMER

This product includes certain copyrighted third-party software components licensed under the terms of the GNU General Public License, PSF LICENSE AGREEMENT FOR PYTHON 2.3, and other similar license agreements offering free distribution of these software components offered by organizations such as Free Software Foundation, Python Software Foundation, the X.Org Foundation, etc. You can check the documentation in your recovery CD-ROM disc to learn more detail about these licensed components. Copies of these license agreements can be found at this file or by visiting the respective website of these components as provided in the documentation. You may also visit <http://www.gnu.org/copyleft/gpl.html> for a copy of GNU General Public License Agreement.

GPL components and other components listed are licensed without warranties of any kinds, either express or implied warranties, including without limitation the implied warranty of merchantability and fitness for a particular purpose. The entire risk as the quality and performance of these components is with you. Please check the respective license agreement for more details.

Copyright holders under GPL and/or other license agreement mentioned herein shall not be responsible for any damages, general, special, incidental or consequential, arising out of the use or inability to use these components/software. Please check the respective license agreement for more details.

## DOWNLOAD SOURCE CODE

You can download the machine-readable full source code of the corresponding licensed components, including any scripts to control compilation and installation of the object code, at the following website link. Please pay attention to the copyright notice, warranty disclaimer and a copy of license agreement accompanying these source codes.

[http://www.gocyberlink.com/pcmlinuxgpl\\_medion.htm](http://www.gocyberlink.com/pcmlinuxgpl_medion.htm)

# Standards

This PC meets the requirements of the following standards:

## ELECTROMAGNETIC COMPATIBILITY

This PC meets the following requirements for standards of electromagnetic compatibility and electrical safety:

<b>EN 55022</b>	Information technology equipment - Radio disturbance characteristics - Limits and methods of measurement.
<b>EN 55024</b>	Information technology equipment - Immunity characteristics - Limits and methods of measurement.
<b>EN 61000-3-2</b>	Limits - Limits for harmonic current emissions (equipment input current up to and including 16 A per phase).
<b>EN 61000-3-3</b>	Limits - Limitation of voltage fluctuations and flicker in low-voltage supply systems for equipment with a rated current up to 16 A.

## ELECTRICAL SAFETY

<b>EN 60950-1</b>	Safety of information technology equipment.
-------------------	---



## ERGONOMICS

Ergonomic requirements according to the following standards:

<b>DIN EN ISO</b>	Ergonomic requirements for office work with display devices:
<b>9241-3</b>	<b>Part 3:</b> Requirements for visual displays
<b>9241-4</b>	<b>Part 4:</b> Requirements for keyboards
<b>9241-8</b>	<b>Part 8:</b> Requirements for colour representation
<b>9241-9</b>	<b>Part 9:</b> Input devices except keyboards

## NOISE EMISSION

Requirements for noise emission according to the measurement procedure in accordance with the following standard:

<b>ISO 7779 (ISO 9296)</b>	Acoustics. Measurement of airborne noise emitted by information technology and telecommunications equipment.
----------------------------	--

This PC fulfils the requirements of noise emissions according to ISO 7779 with following values:

<b>Operating Mode</b>	<b>Max. Sound power level <math>L_{WAd}</math> (B/A) (declared according to ISO 9296)</b>
<b>Idling</b>	4.8
<b>Operating</b>	5.2
<b>Max. Sound pressure level <math>L_{pAm}</math> (dB/A) (declared according to ISO 9296)</b>	
<b>At bystander position Idling</b>	40
<b>St bystander position Operating</b>	47

## **INFORMATION ABOUT THE REGULATORY COMPLIANCE OF THE MODEM**

This PC, if equipped with a modem, has been tested according and complies with the European regulatory guidelines for radio equipment and telecommunication installations (R&TTE 1999/5/EG).

The modem meets the requirements of TBR21 (01/1998) and EG201120/V1.1.1/01/98 regarding connection with an analogue telephone network.

## **INFORMATION ABOUT THE REGULATORY COMPLIANCE OF WIRELESS KEYBOARD / MOUSE**

The following low power radio equipment, which has separately been tested and approved according R&TTE guideline (1999/5/EC), is bundled with this PC:

- Wireless keyboard / mouse / receiver

These radio devices are marked individually with the CE mark.

The declarations of conformity of these radio devices are available under **[www.medion.com/conformity](http://www.medion.com/conformity)**.

## FCC COMPLIANCE STATEMENT

This equipment has been tested and found to comply with the limits for a Class B digital device, pursuant to Part 15 of FCC Rules. These limits are designed to provide reasonable protection against harmful interference in a residential installation. This equipment generates, uses, and can radiate radio frequency energy and, if not installed and used in accordance with the instructions, may cause harmful interference to radio communications. However, there is no guarantee that interference will not occur in a particular installation. If this equipment does cause harmful interference to radio or television reception, which can be determined by turning the equipment off and on, the user is encouraged to try to correct the interference by one or more of the following measures:

- Reorient or relocate the receiving antenna.
- Increase the separation between the equipment and receiver.
- Connect the equipment into an outlet on a circuit different from that to which the receiver is connected.
- Consult the dealer or an experienced technician for help.

Changes or modifications not expressly approved by the party responsible for compliance could void the user's authority to operate the equipment. Shielded interface cables, if any, must be used in order to comply with the emission limits.

# Warranty

The receipt serves as proof of first purchase and should be kept in a safe place. Your legal rights **are not limited** by these warranty conditions. It is required should you need to make use of the guarantee.

We guarantee that this equipment is in perfect working order. Upon production of the receipt, the remaining period of guarantee shall pass on from the original parts to the respective replacement parts. If you hand in this equipment to make use of the guarantee, you must remove all programs, data and removable storage media. Products which are sent without accessories will be replaced without accessories. The warranty obligation does not apply in the case of the problem being caused by an accident, a catastrophe, vandalism, misuse, incorrect use, ignoring the safety and maintenance regulations, changes by software, viruses or another piece of equipment or accessories or by other modifications not approved by ourselves. This limited guarantee declaration replaces all other guarantees of express or implied nature. This includes the guarantee of saleability or the suitability for a certain purpose but is not limited to this. In some countries the exclusion of implied guarantees is not permissible upon principle. In this case the validity of all express and implied guarantees is limited to the guarantee period. Once this period has expired, all guarantees become invalid. In some countries limiting the period of validity for implied guarantees is not permitted, so that the above limitation does not come into force. If you have any questions with regard to these guarantee conditions, please contact us.

## LIABILITY LIMITATIONS

The contents of this manual are subject to unannounced changes caused by technical progress. Manufacturer and sales shall not be responsible for any damages which have been caused as a result of omissions or errors in the information provided in this manual.

Under no circumstances shall we be liable for any of the following:

1. Claims made against you by third parties based on loss or damage.
2. Loss or damage to your blanks, recordings or data.
3. Economic follow-on damage (including lost profit or savings) or associated damage even in the case that we have been informed of the possibilities of this type of damage.

In some countries the exclusion or limitation of accompanying or follow-on damage is not legally accepted so that the above limitations do not come into force.

## MAKING COPIES OF THIS MANUAL

This manual contains information protected by law. All rights reserved. Duplicating this information in mechanical, electronic, or any other form, without the written approval by the manufacturer, is prohibited by copyright law.

# Index

---

## A

Ambient temperature.....8  
Audience ..... ii  
Autorun ..... 71

---

## C

Cabling ..... 12  
Card reader ..... 48  
Care ..... 88  
CD-blanks ..... 47  
CD-ROM ..... 44  
CD-Rom-/DVD-Drive as bootdrive 45  
CF ..... 48  
Cleaning ..... 88  
Cleaning agents ..... 88  
COM1 ..... 66  
Compact Flash ..... 48  
Connecting ..... 12  
    Antenna for TV ..... 25  
    Keyboard ..... 19  
    Microphone ..... 24  
    Modem/ISDN ..... 20  
    Monitor..... 14  
    Parallel devices..... 19  
    Recording ..... 23  
    Serial devices..... 21  
    Sound source /audio input ..... 23  
    Speakers/audio output ..... 22  
    Television ..... 24  
    USB devices ..... 26  
    Video inlet ..... 23  
Customer service ..... 85

---

## D

Data and system security .....77  
Data security ..... 4, 77  
Directories .....42  
Disc drive .....44  
Driver support.....87  
Dual-Tuner .....56

---

## E

Electrical safety .....96  
Electromagnetic compatibility.....96  
Ergonomics ..... 9

---

## F

FAQ .....83  
FCC compliance statement.....99  
Frequently Asked Questions .....83  
Front connectors .....13

---

## G

Graphics card .....49

---

## H

Hard drive .....41  
HD..... See Hard drive  
Hotline .....87

---

<b>I</b>	
IBM® Microdrive .....	48
IEEE 1394 (Fire Wire) .....	54

---

<b>K</b>	
Keyboard .....	38
Inserting batteries .....	16
Keys .....	38
Multimedia functions .....	39

---

<b>L</b>	
Laser radiation .....	92
License agreement .....	95
License Agreement .....	30

---

<b>M</b>	
Main Power Switch .....	29
Maintenance .....	88
Maintenance programs .....	77
Memory Stick .....	48
MMC .....	48
Modem / ISDN .....	66
Mouse .....	37
Inserting batteries .....	15
MultiMediaCard .....	48

---

<b>N</b>	
Nero .....	69
Network .....	63
LAN access point .....	64
Troubleshooting .....	65
What is a network? .....	63
Wireless LAN .....	64
Noise emission .....	97

---

<b>O</b>	
Operation	
Keyboard .....	38
Mouse .....	37
Operational safety	
Connecting .....	12
Optical disc drive .....	44

---

<b>P</b>	
Password reset file .....	77

---

<b>Q</b>	
Quality .....	ii

---

<b>R</b>	
Remote control .....	55
Restore .....	82

---

<b>S</b>	
SD .....	48
Secure Digital .....	48
Serial number .....	ii
Service engineers .....	91
Set-up location .....	8
SmartMedia .....	48
Software uninstallation .....	72
Sound card .....	52
Standards	
Electrical safety .....	96
Electromagnetic compatibility .....	96
FCC compliance statement .....	99
Noise emission .....	97
Surround sound .....	22
System recovery .....	78

---

**T**

Transporting .....	88
Troubleshooting .....	78, 85
TV tuner card .....	55

---

**U**

USB port .....	53
USB/IEEE 1394 .....	26

---

**W**

Warranty .....	100
Windows activation .....	73
Windows® Desktop .....	31
Windows® Update .....	79
Wireless LAN .....	64
Writing CDs .....	69